

U P S

Uninterruptible Power System

Line-Interactive Network UPS

1000AL/ 2000AL/ 1000XL/ 2000XL

■ USER'S MANUAL ■

IMPORTANT SAFETY INSTRUCTIONS

IMPORTANT SAFETY INSTRUCTIONS

SAVE THESE INSTRUCTIONS

- **WARNING (SAVE THESE INSTRUCTIONS):** This manual contains important instructions should be followed during installation and maintenance of the UPS and batteries.
- **WARNING:** Intend for installation in a controlled environment.
- Servicing of batteries should be performed or supervised by personnel knowledge of batteries and the required precautions. Keep unauthorized personnel away from batteries.
- When replacing batteries, replace with the same number and type.
- **CAUTION:** Do not dispose of batteries in a fire, the battery may explode.
- **CAUTION:** Do not open or mutilate the battery, released electrolyte is harmful to the skin and eyes. It may be toxic.
- **CAUTION:** A battery can present a risk of electric shock and high short circuit current. The following precaution should be observed when working on batteries
 - A. Remove watches, rings or other metal objects.
 - B. Use tools with insulated handles.
 - C. Wear rubber gloves and boots.
 - D. Do not lay tools or metal parts on top of batteries.
 - E. Disconnect charging source prior to connecting or disconnecting battery terminals.

TABLE OF CONTENTS

IMPORTANT SAFETY INSTRUCTIONS.....	1
TABLE OF CONTENTS.....	2
INTRODUCTION.....	3
1. PRESENTATION.....	4
2. INSTALLATION.....	6
3. OPERATION.....	8
4. SOFTWARE AND COMPUTER INTERFACE.....	9
5. REPLACEMENT AND PARK INSTALLATION.....	9
APPENDIX A. TROUBLESHOOTING.....	11
APPENDIX B. SPECIFICATIONS.....	12

INTRODUCTION

Please read and save this manual!

Thank you for selecting this uninterruptible power system (UPS). It provides you with a perfect protection for connected equipment. The manual is a guide to install and use the UPS. It includes important safety instructions for operation and correct installation of the UPS. If you should have any problems with the UPS, please refer to this manual before calling customer service.

Please save or recycle the packaging materials!

The UPS's shipping materials are designed with great care to provide protection within delivery. These materials are invaluable if you ever have to return the UPS for service. Damage happened during transit is not covered under the warranty.

Intelligent microprocessor control

The UPS is a microprocessor-controlled unit. This means that it operates with the newest technology, high performance and powerful function.

The UPS is an intelligent protector and provides pure, reliable AC power to the critical loads - protecting them from utility power blackout, swells, sags, surges and interference.

Furthermore, in order to save the battery energy, UPS can automatically turn it off under backup mode if none of the connected loads is operating.

Advanced battery management

The visual and audible indications of the UPS present the battery's status. Self-test function let UPS detect a weak battery before it is put into service. The UPS normally perform a self-test at power up condition.

1. PRESENTATION

FRONT PANELS

1.1 "REPLACE BATTERY" indicator (RED LED)

The LED illuminates when the UPS's battery is no longer useful and must be replaced.

1.2 "BUCK AVR (VOLTAGE REDUCTION)" indicator (YELLOW LED)

The LED illuminates when the UPS is correcting a high utility voltage condition. The loads receive normal power.

1.3 "BACK UP" indicator (YELLOW LED)

The LED illuminates when the UPS is supplying battery power to the loads.

1.4 "BOOST AVR (VOLTAGE BOOST)" indicator (YELLOW LED)

The LED illuminates when the UPS is correcting a low utility voltage condition. The loads receive normal power.

1.5 "LINE NORMAL" indicator (GREEN LED)

1.6 "ON/OFF/TEST/SILENCE" button

Press the button more than 2 seconds to turn the UPS on or off, press the button less than 1 second to activate the UPS's self-testing or silence the back up alarm.

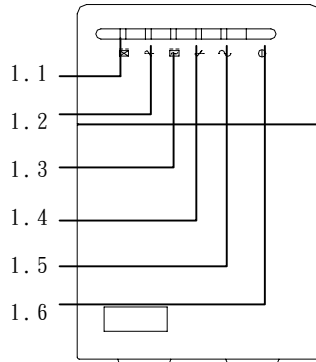

REAR PANELS

1.10 MAIN SWITCH

1.11 REMOTE PORT (COMPUTER INTERFACE)

Provide both RS-232 and relay signal to support NOVELL, UNIX, DOS, WINDOWS and other operating systems.

1.12 TEL./MODEM port

Telecom transfer ports provide users to extend the applications.

● **Caution:** To reduce the risk of fire, use only No. 26AWG or larger telecommunication line cord.

1.13 SITE WIRING FAULT INDICATORS (RED LED)

It comes on when the UPS is connected to an improperly wired AC power outlet.

Note: This device is available on 110 Vac model only.

1.14 BYPASS OUTPUT POWER RECEPTACLES

1.15 EXTERNAL BATTERY PACK CONNECTOR (optional)

Caution: Use only factory supplied or authorized connecting cable for external battery !

1.16 UPS OUTPUT RECEPTACLES

1.17 AC INPUT POWER RECEPTACLE

1.18 INPUT CIRCUIT BREAKER

It trips when the connected loads exceed the protected receptacle's capacity, The center plungers of the circuit breakers extend when tripped.

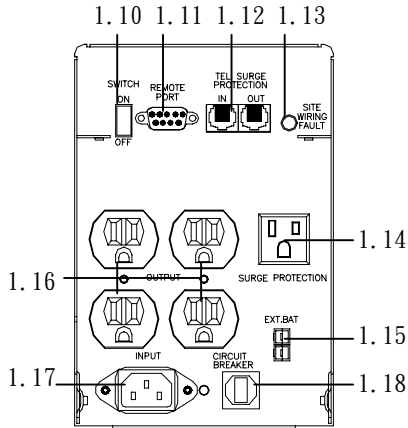

1000AL/1000XL (110V)

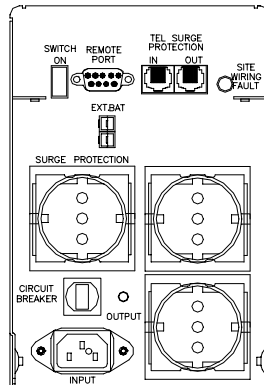

1000AL/1000XL (220V)

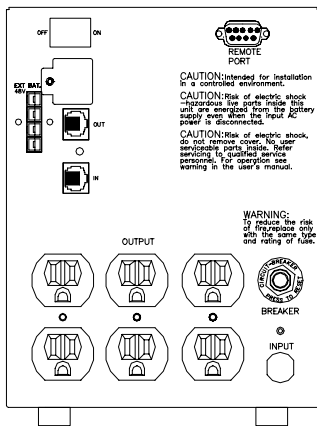

2000AL/2000XL (110V)

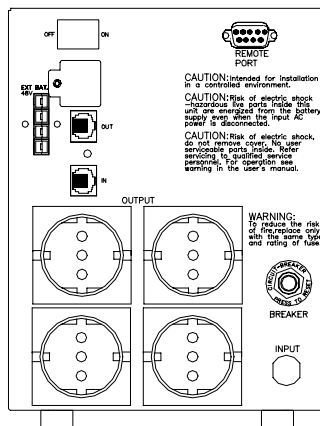

2000AL/2000XL (220V)

2. INSTALLATION

Inspect the UPS upon receipt. The packaging is recyclable; keep it for reuse or disposed of properly.

2.1 Recharge the battery

UPS may be used by anyone immediately upon receipt. The battery is fully charged before shipped from the factory. However, user is recommended to recharge the battery at least four hours before using UPS. Energy loss may occur during shipping or long duration storage. To recharge the battery, simply let UPS be plugged into an AC outlet and switch it on.

2.2 Connect the loads

Plug your primary equipment (e.g. computer, monitor and critical data storage device, etc.) to the Battery Power-Supplied outlets. Plug your peripheral equipment (e.g. printer, scanner, fax, or audio device) to the Full-time Surge Protection outlets. Do not plug laser printer to the UPS output outlets, as its power demand is much higher than typical peripherals and may cause the circuit breaker to trip. It is suggested to connect the similar heavy loads (like laser printer) to the bypass outlets.

2.3 Connect the telephone

If you wish to extend the length of wire of, connect the telephone cable from the wall outlet to the "IN" jack. Connect the telephone cable (provided) from the "OUT" jack to the fax or modem.

2.4 Connect to the utility power

Plug UPS to a 2-pole, 3-wire grounding receptacle. Make sure the branch is protected and does not service equipment requiring heavy electricity (e.g. refrigerator, air conditioner, copier, etc.).

2.5 UPS self-test

UPS will conduct a self-test once switched on it each time. Do not add or take off any equipment while UPS conducts self-test; await it until the Power indicator lights up. Besides this, switch on your equipment after switch on UPS.

2.6 Battery auto-charging

Once the power cord is connected, the battery of UPS will be automatically charged by itself.

2.7 Auto restart feature

UPS is equipped with Auto Restart feature. It will activate when the battery level becomes too low to sustain its operation and the utility is not present. UPS will switch itself to waiting mode, waiting for utility switch itself on and recharge its battery. If the user is away during a utility failure, UPS will manage to return to normal function and recharge its battery when utility power returns.

2.8 Overload protection

If an overload situation is detected during self-test, UPS audible alarm will activate, emit a long beep and automatically shut down the system. Unplug at least one piece of equipment from the Battery Supplied Outlets. Switch off UPS, wait 5 seconds and check to make sure the circuit breaker is set then switch on, again. User is allowable to change the fuse under overload condition.

2.9 Optimal battery status

To maintain the optimal status of battery, let UPS be always plugged in.

2.10 Self-protection feature

UPS is equipped with self-protection feature preventing people from playing with the unit to subsequently damaging the unit. It is programmed so that once switched off, the user must wait 5 seconds before switching UPS on again.

2.11 Storage

To store UPS, cover it and store it with the battery fully charged. During extended storage, recharge the battery every three months to ensure battery life.

2.12 Power failure

When the event of power failure occurs after turning on UPS, and prior to the self-test sequence, UPS will automatically shut down and not restart until utility power is restored. This is necessary to check the quality of power that is delivered to your connected equipment.

3. OPERATION

3.1 Simple test

It is recommended that the user perform a simulation test when using UPS for the first time or when adding an additional piece of equipment. Conduct a simulation-test: first, switch on UPS and wait for the power indicator to light up, then simply unplug UPS to simulate the event of utility failure.

3.2 Check the power requirement of your equipment

3.2.1. Make sure the total power of your equipment does not exceed rating capacity.

3.2.2. Also make sure the equipment you plugged into the Battery Power-Supplied outlets does not require total power exceeding the capacity of the UPS. Otherwise, overload may occur and cause the circuit breaker to trip. If the power requirement of your equipment differs from VA, convert the requirement power into VA by doing the calculations below:

3.2.3. If the power requirement of your equipment is listed other than VA, convert the requirement into VA by doing the calculations below.

___ Watt (W) X 1.67 = ___ VA, or ___ Amps(A) X 120= ___ VA (For 100-120V model)

___ Watt (W) X 1.67 = ___ VA, or ___ Amps(A) X 230= ___ VA (For 220-240 model)

3.3 Limited rating power of UPS

When utility failure occurs, the UPS output outlets will supply power to your equipment from its battery and the alarm will beep every 2 seconds. Be sure that your equipment is running under the limited rating power. To restore the utility by plugging UPS back in to the existing power source. Repeat the test a few times to make sure UPS works properly and to find out the expected runtime.

4. SOFTWARE AND COMPUTER INTERFACE

4.1 Power Monitoring Software

The UPS-MON series software (or other power monitoring software) is applied standard RS-232 interface to perform monitoring functions, and then provides an orderly shutdown of a computer in the event of power failure. Moreover, UPS-MON displays all the diagnostic symptoms on monitor, such as Voltage, Frequency, Battery level and so on. The software is available for DOS, Windows 3.1x, Windows 95/97/2000, Windows NT V3.5 or later, Novell Netware, Linux and others. Call your dealer for more information on computer OS compatible solutions.

4.2 Interface Kits

A series of interface kits is available for operation systems that provide UPS monitoring. Each interface kit includes the special interface cable required to convert status signals from the UPS into signals which individual operating system recognize. The interface cable at UPS side must be connected to REMOTE PORT, at computer side can be either COM 1 or COM 2. The other installation instructions and powerful features please refer to READ.ME file.

CAUTION: Use only factory supplied or authorized UPS monitoring cable!

4.3 The characteristics of computer interface port

The computer interface port has the following characteristics:

The communication port on the back of the UPS may be connected to host computer. This port allows the computer to monitor the status of the UPS and control the operation of the UPS in some cases. Its major functions normally include some or all of the following:

- To broadcast a warning when power fails.
- To close any open file before the battery is exhausted.
- To turn-off the UPS.

Some computers are equipped with a special connector to link with the communication port. In addition, special plug-in cord may be needed. Some computers may need special UPS monitoring software. Contact your dealer for the details on the various interface Kits.

5. REPLACEMENT AND PARK INSTALLATION

5.1 Battery's life of UPS

The battery's life of UPS is about 3-6 years under normal usage.

5.2 Installation of battery cabinet and UPS:

Please follow the listed steps and illustration to complete the installation.

5.2.1 Turn off the UPS and remove the connector metal cover from the back panel of UPS.

5.2.2 Connect the battery cabinet's DC wire to the UPS and fix the metal cover via a screwdriver. Beside this, make sure the connection is reliable.

5.2.3 Turn on the UPS and plug the loads behind the UPS.

CAUTION: Do not dispose of battery in fire.

CAUTION: Do not attempt to open the battery.

CAUTION: The following precautions should be taken when replacing the battery

- a. Remove watches, rings, etc...
- b. Use tools with insulated handles

Figure for the Installation of battery cabinet and UPS

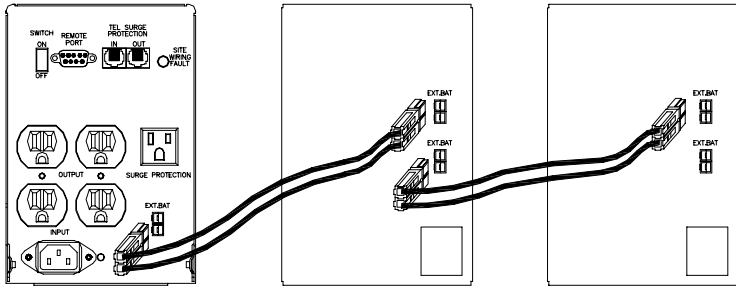

1000XL/ 1000AL

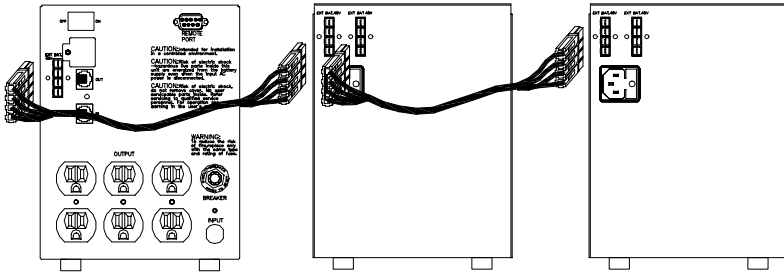

2000XL/ 2000AL

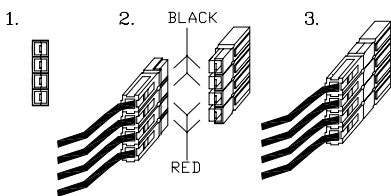

1000XL/ 1000AL

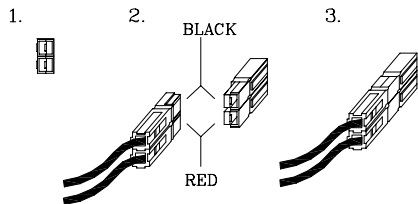

2000XL/ 2000AL

APPENDIX A TROUBLESHOOTING

UPS has a self-protect feature that prevents the UPS from being damaged as a result of overheating. If the temperature is higher than 40°C, wait for a while and let the UPS become cool.

Problems	Possible Cause	Solution
Full-time Surge Protection outlets stop providing power to the equipment	Circuit breaker button popped up as a result of overload.	Unplug at least one piece of equipment from the Full-time Surge Protection outlets. Switch off UPS, wait 5 seconds, reset the circuit breaker (press down breaker button), then switch on UPS.
UPS doesn't perform to its expected runtime.	Battery undercharged or depleted due to frequent power outages.	Recharge the battery by leaving the UPS plugged in and switched on.
	The power required by your equipment slightly exceeds the capacity of the UPS.	Unplug at least one piece of equipment from the UPS outlets.
	The battery is slightly worn-out.	Consider replacing the battery.
UPS cannot be turned on.	Special UPS is designed to prevent damage from flipping.	Switch UPS off, wait for 5 seconds, then switch UPS on.
	The battery is worn-out.	Replace the battery by following the instructions in this manual.
	Mechanical problem.	Contact your sales representative.

APPENDIX B SPECIFICATIONS

MODEL		1000AL	2000AL	1000XL	2000XL
INPUT	Capacity (On Battery)	1000VA /600W	2000VA /1200W	1000VA /600W	2000VA /1200W
	Voltage	+/-25% at line input			
	Frequency	50 or 60 Hz +/-10% (auto sensing)			
OUTPUT	Voltage (on battery)	Simulated sine wave at +/- 5% of nominal			
	Frequency (on battery)	50 or 60 Hz +/- 0.5%			
	Voltage Regulation (AVR)	AVR automatically increase output voltage 15% above input voltage if -9% to -25% of nominal. AVR decrease output voltage 13% below input voltage if +9% to +25% of nominal			
	Transfer	2/4 milliseconds, including detection time			
PROTECTION And FILTERING	Spike Protection	320 Joules, 2ms			
	EMI/RFI filter	10dB at 0.15MHz, 50db at 30MHz			
	Overload Protection	UPS automatic shutdown if overload exceeds 110% of nominal at 60 seconds and 130% at 3 seconds			
	Unit Input	Circuit Breaker for overload & Short circuit protection			
	10Base-T Cable Port	Network (UTP,RJ-45) compatible jacks			
	Short Circuit	UPS output cut off immediately or input fuse protection			
BATTERY	Type	Sealed, Maintenance-free lead acid			
	Typical Recharge Time	4 hours (to 90% of full capacity)			
	Protection	Automatic self-test & discharge protection, Replace battery indicator			
	Charger Circuit	2.6A	1.8A	0.6A	0.8A
	Build in Battery	No	No	12V 7Ah*2	12V 7Ah*4
PHYSICAL	Net Weight Kg (lbs)	15.1 (33.22 lb)	19.5 (42.9 lb)	19.8 (43.56 lb)	28.9 (63.58 lb)
	Shipping Weight Kg (lbs)	16.3 (38.86 lb)	22 (48.4 lb)	21 (46.2 lb)	31.4 (69.08 lb)
	Dimension (mm) W*D*H	130*382 *201 (5.1"*15" *7.9")	169*438.5 *215 (6.7"*17.3 *8.5")	130*382 *201 (5.1"*15" *7.9")	169*438.5 *215 (6.7"*17.3"*8 .5")
	Input Inlet	IEC 320 power inlet			
	Receptacles	NEMA 5-15R(115V) / IEC 320 female appliance coupler(230V)			
	ALARM	Battery Back-up	Slow beeping sound (about 0.25Hz)		
Battery Low		Rapid beeping sound (about 1.00Hz)			
Overload		Continue beeping sound			
INTERFACE	Dry Contact	AC fail. battery low. shutdown signal			
	RS-232 Interface	Bi-directional communication port			
ENVIRONMENT	Ambient Operation	3,500 meters max. elevation, 0-95% humidity non-condensing, 0-40 deg C			
	Audible Noise	< 40dBA (1 meter from surface)			
	Storage Condition	15000 meter max. elevation			

©2002, Feb.25 Version 2.0 All right Reserved.

All trademarks are property of their respective owners. Specifications subject to change without notice.